

MTA ELECTRICAL PRODUCTS



FUSES

FUSE & RELAY HOLDERS

POWER DISTRIBUTION UNITS

CONNECTORS & TERMINALS

BATTERY TERMINALS

FEATURES

- **Pro Quip** has Australia's most extensive range of MTA Automotive Electrical products which are designed and manufactured to meet the demands for the manufacture, repair and maintenance of vehicle electrical systems.
- **MTA complies** with most Internationally recognised quality systems including ISO9001:2000, and the ISO/TS 16949 technical specification, as well as an environmental management system: The ISO 14001.
- **All Fuses** comply with ISO 8820.
- **MTA products** are supplied as Original Equipment to Audi, BMW, Case New Holland, DaimlerChrysler, Deutz-Fahr, Ducati, Ferrari, Fiat, Ford, GM, Iveco, John Deere, Peugeot-Citroen, Renault and Volkswagen.
- **MTA test** every product to a "qualification phase" during which a number of tests are performed: Electrical tests, Mechanical tests, Environmental tests, Tests on Materials and actual application simulation.
- **All Products** conform to stringent Original Equipment specifications.





MTA FUSES

Please Note: Commonly ordered items shown only, Full Range available upon request

MINIVAL FUSE			
PRODUCT	STOCK CODE	DESCRIPTION	OUTER QTY
<p>See page 54-58 for Holders</p>	M0600110	5A MINIVAL FUSE BEIGE	25
	M0600120	7.5A MINIVAL FUSE BROWN	25
	M0600130	10A MINIVAL FUSE RED	25
	M0600140	15A MINIVAL FUSE BLUE	25
	M0600150	20A MINIVAL FUSE YELLOW	25
	M0600160	25A MINIVAL FUSE NATURAL	25
	M0600170	30A MINIVAL FUSE GREEN	25
	M3004000	6pc MINIVAL FUSE ASSORTED PACK 1 Pc each of: 3A 5A 10A 15A 20A 30A	50
UNIVAL FUSE			
PRODUCT	STOCK CODE	DESCRIPTION	OUTER QTY
<p>See page 54-58 for Holders</p>	M0600380	1A UNIVAL FUSE BLACK	100
	M0600390	2A UNIVAL FUSE GREY	100
	M0600400	3A UNIVAL FUSE VIOLET	100
	M0600410	5A UNIVAL FUSE BEIGE	100
	M0600420	7.5A UNIVAL FUSE BROWN	100
	M0600430	10A UNIVAL FUSE RED	100
	M0600440	15A UNIVAL FUSE BLUE	100
	M0600450	20A UNIVAL FUSE YELLOW	100
	M0600460	25A UNIVAL FUSE WHITE	100
	M0600470	30A UNIVAL FUSE GREEN	100
	M0600375	40A UNIVAL FUSE ORANGE	100
	M0600408	10pc UNIVAL FUSE ASSORTED PACK 1 Pc each of: 3A 5A 7.5A 15A 25A 30A 2 Pcs each of: 10A 20A	1
	M0650015	80pc UNIVAL FUSE ASSORTED PACK 10 Pcs each of: 4A 5A 7.5A 10A 15A 20A 25A 30A	1
MAXIVAL FUSE			
PRODUCT	STOCK CODE	DESCRIPTION	OUTER QTY
<p>See page 54-58 for Holders</p>	M0600900	20A MAXIVAL FUSE YELLOW	10
	M0600910	30A MAXIVAL FUSE GREEN	10
	M0600920	40A MAXIVAL FUSE ORANGE	10
	M0600930	50A MAXIVAL FUSE RED	10
	M0600940	60A MAXIVAL FUSE BLUE	10
	M0600950	70A MAXIVAL FUSE BEIGE	10
	M0600960	80A MAXIVAL FUSE NATURAL	10
	M0600970	100A MAXIVAL FUSE VIOLET	10

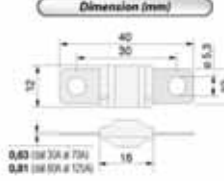

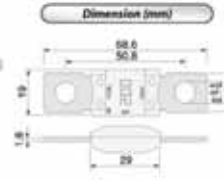
MTA FUSES

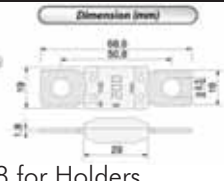
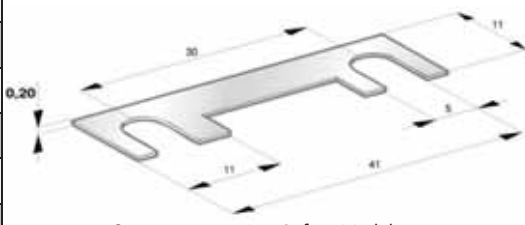
Please Note: Commonly ordered items shown only, Full Range available upon request

MIDIVAL FUSE			
STOCK CODE	DESCRIPTION	OUTER QTY	PRODUCT
M0602040	40A MIDIVAL FUSE GREEN	1	  <p>See page 54-58 for Holders</p>
M0602060	60A MIDIVAL FUSE YELLOW	1	
M0602080	80A MIDIVAL FUSE WHITE	1	
M0602100	100A MIDIVAL FUSE BLUE	1	
M0602125	125A MIDIVAL FUSE PINK	1	
MEGAVAL FUSE			
STOCK CODE	DESCRIPTION	OUTER QTY	PRODUCT
M0601100	100A MEGAVAL FUSE YELLOW	1	  <p>See page 54-58 for Holders</p>
M0601125	125A MEGAVAL FUSE GREEN	1	
M0601150	150A MEGAVAL FUSE ORANGE	1	
M0601175	175A MEGAVAL FUSE WHITE	1	
M0601200	200A MEGAVAL FUSE BLUE	1	
M0601225	225A MEGAVAL FUSE BEIGE	1	
M0601250	250A MEGAVAL FUSE PINK	1	
M0601600	500A MEGAVAL FUSE BROWN	1	
POWERVAL FUSE			
<p>The POWERVAL® family of fuses were developed to satisfy the electrical protection requirements of the starter/alternator line. External shapes and dimensions are the same as the ones of MEGAVAL® family fuses, in order to allow the maximum flexibility and interchangeability for actual applications and boxes dimensions compatibility. The objects of the POWERVAL® family present peculiar electrical characteristics in order to operate correctly with the typical stresses of the starter/alternator line. Particular care has been given to the dimensioning of the critical characteristics listed below:</p> <ul style="list-style-type: none"> • Rated current of 150A (value fixed from the present alternators maximum output current) • Resistance to starting cycles • Breaking capacity. <p>I.R.: 1000A at rated voltage VOLTAGE: 32VDC</p>			
STOCK CODE	DESCRIPTION	OUTER QTY	PRODUCT
M0701350	POWERVAL FUSE CAL.1 GREY Min/Max Melt. Current: 380A/2000A	1	  <p>See page 54-58 for Holders</p>
M0701400	POWERVAL FUSE CAL.2 BLACK Min/Max Melt. Current: 400A/2000A	1	
M0601450	POWERVAL FUSE CAL.3 RED Min/Max Melt. Current: 530A/2000A	1	
STRIP FUSE			
STOCK CODE	DESCRIPTION	OUTER QTY	PRODUCT
M0200296	30A STRIP FUSE (0.20mm)	100	 <p>See page 54-58 for Holders</p>
M0200300	40A STRIP FUSE (0.25mm)	100	
M0200297	50A STRIP FUSE (0.35mm)	100	
M0200301	60A STRIP FUSE (0.40mm)	100	
M0200298	80A STRIP FUSE (0.50mm)	100	
M0200299	100A STRIP FUSE (0.55mm)	100	

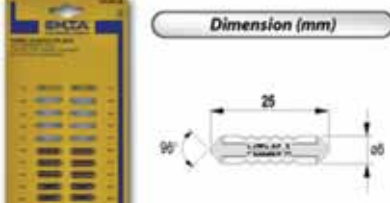
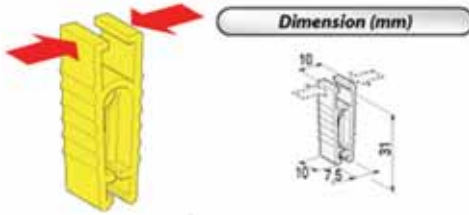
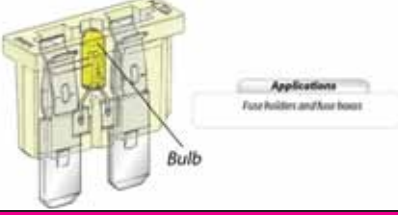
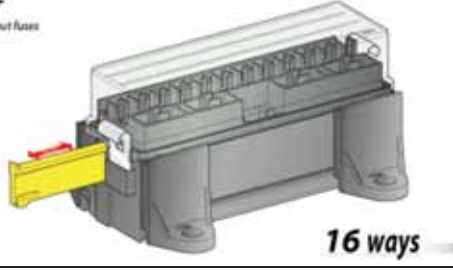

MTA FUSE & RELAY HOLDERS

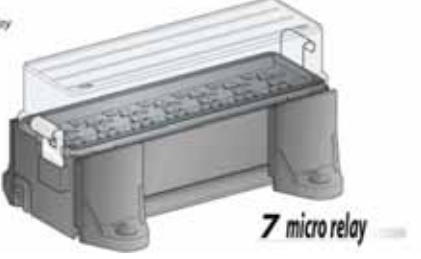
Please Note: Commonly ordered items shown only, Full Range available upon request

ADDITIONAL FUSES & ACCESSORIES			
PRODUCT	STOCK CODE	DESCRIPTION	OUTER QTY
 <p>Dimension (mm)</p>	M0200138	CERAMIC FUSES: 20PC ASSORTED PACK 2 pcs 5A, 8 pcs 8A, 6 pcs 16A, 4 pcs 25A	10
 <p>Dimension (mm)</p>	M0100358	FUSE EXTRACTOR - MINIVAL TO MAXIVAL - YELLOW	25
 <p>Applications Fuse holders and fuse boxes</p> <p>Bulb</p>	M0600200	BLOWN FUSE WARNING LIGHT This is a very useful accessory, as it can be mounted on all fuse boxes which are equipped with homologated blade fuses from 1A to 40A. We suggest you plug a "warning light" in at the place of every fuse in the fuse-box in order to protect all electrical equipment devices. We recommend you replace blown blade fuses with homologated ones.	10
FUSE & RELAY HOLDER UNITS			
PRODUCT	STOCK CODE	DESCRIPTION	OUTER QTY
 <p>KIT Without fuses</p> <p>16 ways</p>	M0100655	UNIVAL 16 WAY FUSE HOLDER KIT (STACKABLE)	1
 <p>KIT Without relay</p> <p>4 relay</p>	M0100665	4 WAY RELAY BOX KIT (STACKABLE)	1
 <p>KIT Without relay</p> <p>7 micro relay</p>	M0100705	7 WAY MICRO RELAY BOX KIT (STACKABLE)	1
See page 58	M0300690	MOUNTING BRACKET(MALE) SUITS: M0100655 / M0100665 / M0100705	100

MTA FUSE & RELAY HOLDERS

Please Note: Commonly ordered items shown only, Full Range available upon request

FUSE HOLDERS			
STOCK CODE	DESCRIPTION	OUTER QTY	PRODUCT
M0301435	MINIVAL KIT FRAME & FUSE HOLDER	1	
M0100540	UNIVAL AXIAL 4 WAY FUSE HOLDER KIT	1	4 ways 
M0100560	UNIVAL AXIAL 6 WAY FUSE HOLDER KIT	1	6 ways 
M0100580	UNIVAL AXIAL 8 WAY FUSE HOLDER KIT	1	8 ways 
M0100590	UNIVAL SIDE EXIT 8 WAY FUSE HOLDER	1	8 ways 
M0100600	UNIVAL SIDE EXIT 6 WAY FUSE HOLDER	1	6 ways 
M0100610	UNIVAL SIDE EXIT 4 WAY FUSE HOLDER	1	4 ways 

MTA 1-WAY FUSE HOLDERS

Please Note: Commonly ordered items shown only, Full Range available upon request

1-WAY MINIVAL FUSE HOLDERS														
PRODUCT	STOCK CODE	DESCRIPTION	OUTER QTY											
KIT   <table border="1"> <thead> <tr> <th colspan="2">Contents</th> </tr> </thead> <tbody> <tr> <td>01.00416</td> <td>1 pc</td> </tr> <tr> <td>01.01400</td> <td>1 pc</td> </tr> <tr> <td>01.00295</td> <td>1 pc</td> </tr> <tr> <td>11.02712</td> <td>2 pcs</td> </tr> </tbody> </table>	Contents		01.00416	1 pc	01.01400	1 pc	01.00295	1 pc	11.02712	2 pcs	M3050152	MINIVAL FUSEHOLDER KIT W/COVER & TERMINALS (GANGABLE)	1	
Contents														
01.00416	1 pc													
01.01400	1 pc													
01.00295	1 pc													
11.02712	2 pcs													
	M0100335	MINIVAL WATERPROOF FUSE HOLDER WITH CABLE 4mm ²	5											
1-WAY UNIVAL FUSE HOLDERS														
PRODUCT	STOCK CODE	DESCRIPTION	OUTER QTY											
KIT   <table border="1"> <thead> <tr> <th colspan="2">Contents</th> </tr> </thead> <tbody> <tr> <td>01.00320</td> <td>1 pc</td> </tr> <tr> <td>01.00782</td> <td>1 pc</td> </tr> <tr> <td>11.07620</td> <td>2 pcs</td> </tr> </tbody> </table>	Contents		01.00320	1 pc	01.00782	1 pc	11.07620	2 pcs	M3050153	UNIVAL SPLASHPROOF FUSEHOLDER KIT BLISTER	1			
Contents														
01.00320	1 pc													
01.00782	1 pc													
11.07620	2 pcs													
KIT   <table border="1"> <thead> <tr> <th colspan="2">Contents</th> </tr> </thead> <tbody> <tr> <td>07.00359</td> <td>1 pc</td> </tr> <tr> <td>07.00351</td> <td>1 pc</td> </tr> <tr> <td>07.00352</td> <td>1 pc</td> </tr> <tr> <td>07.00758</td> <td>1 pc</td> </tr> </tbody> </table>	Contents		07.00359	1 pc	07.00351	1 pc	07.00352	1 pc	07.00758	1 pc	M0100353	UNIVAL FUSEHOLDER KIT BLISTER	1	
Contents														
07.00359	1 pc													
07.00351	1 pc													
07.00352	1 pc													
07.00758	1 pc													
  <p>e.g.</p>	M0100334	UNIVAL QUICK LOCK FUSEHOLDER	25											
	M0100336	UNIVAL WATERPROOF FUSE HOLDER WITH CABLE 4mm ²	5											





MTA 1-WAY FUSE & RELAY HOLDERS

Please Note: Commonly ordered items shown only, Full Range available upon request

1-WAY MAXIVAL FUSE HOLDERS			
STOCK CODE	DESCRIPTION	OUTER QTY	PRODUCT
M3001001	MAXIVAL FUSEHOLDER KIT BLISTER TERMINAL 8-10mm ²	1	
M0100337	MAXIVAL WATERPROOF FUSE HOLDER WITH CABLE 10mm ²	5	
1-WAY MIDIVAL FUSE HOLDERS			
STOCK CODE	DESCRIPTION	OUTER QTY	PRODUCT
M0100360	MIDIVAL & STRIP FUSE HOLDER	5	
M0300360	MIDIVAL & STRIP FUSE HOLDER	100	
1-WAY MEGAVAL FUSE HOLDERS			
STOCK CODE	DESCRIPTION	OUTER QTY	PRODUCT
M0100380	MEGAVAL IN-LINE HOLDER KIT WITH MOUNTING CLIP	10	
RELAY HOLDERS			
STOCK CODE	DESCRIPTION	OUTER QTY	PRODUCT
M3050135	MINI RELAY HOLDER (5 PIN) KIT INCLUDES HOLDER, BRACKET & 5x TERMINALS F630	1	
M4410245	MINI RELAY HOLDER SUITS M3050135	20	
M3050136	MAXI RELAY HOLDER (4 PIN) KIT INCLUDES HOLDER, BRACKET & 4 x TERMINALS TO SUIT 70A RELAY	1	

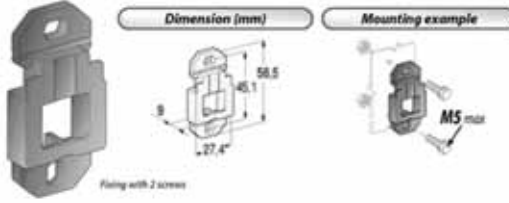
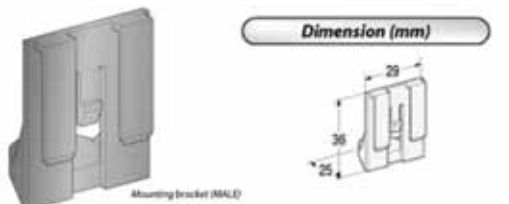
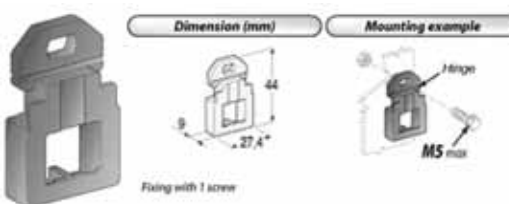
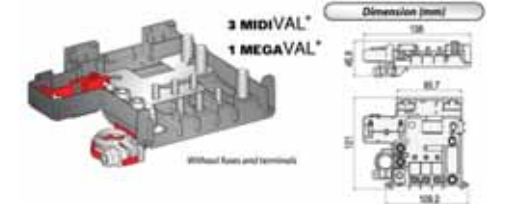
MTA POWER DISTRIBUTION UNITS

Please Note: Commonly ordered items shown only, Full Range available upon request

FUSE AND RELAY HOLDER ADAPTORS & FIXING PLATES			
PRODUCT	STOCK CODE	DESCRIPTION	OUTER QTY
 <p>Dimension (mm): 58.5, 45.1, 27.4, 9</p> <p>Mounting example: M5 max</p> <p>Fixing with 2 screws</p>	M0100440	RELAY HOLDER FIXING PLATE 2 SCREWS	1
 <p>Dimension (mm): 29, 35, 14</p> <p>Mounting bracket (MALE)</p>	M0300690	MOUNTING BRACKET(MALE) SUITS:M0100655 / M0100665 / M0100705	100
 <p>Dimension (mm): 44, 27.4, 9</p> <p>Mounting example: M5 max</p> <p>Fixing with 1 screw</p>	M0100430	FIXING PLATE SUITS: M3050135	10
POWER DISTRIBUTION UNITS			
PRODUCT	STOCK CODE	DESCRIPTION	OUTER QTY
 <p>3 MIdiVAL* 1 MEGAVAL*</p> <p>Without fuses and terminals</p> <p>Dimension (mm): 138, 117, 108.2</p>	M0100750	PDU - PRE-MOUNTED HOUSING & COVER WITHOUT FUSES & TERMINAL (FITS 3 X MIDI, 1 X MEGA/POWERVAL)	1
	M0100011	PDU - PRE-MOUNTED HOUSING & COVER WITHOUT FUSES & TERMINAL (FITS 2 X MIDI, 1 X MEGA/POWERVAL)	1
	M0101703	PDU - PRE-MOUNTED HOUSING W/ COVER & BATTERY TERMINAL WITHOUT FUSES (FITS 1 X MEGA/POWERVAL FUSE)	1
	M0100703	PDU - PRE-MOUNTED HOUSING WITH BATTERY TERMINAL WITHOUT FUSES (FITS 1 X MEGA/POWERVAL FUSE)	1









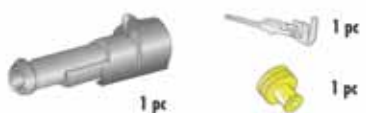
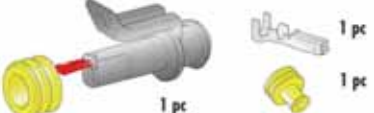

MTA CONNECTORS & TERMINALS

Please Note: Commonly ordered items shown only, Full Range available upon request

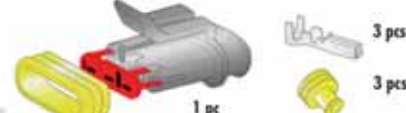
POWER CONNECTORS & TERMINALS			
STOCK CODE	DESCRIPTION	OUTER QTY	PRODUCT
M4440901	2 WAY MALE POWER SPLASH PROOF	10	
M4440900	2 WAY FEMALE POWER SPLASH PROOF	10	
M4440906	GASKET & RETAINER 4 - 6mm ² BLUE	20	
M4440908	GASKET & RETAINER 8mm ² RED	20	
M1107660	TERMINAL FEMALE POWER F800 4-6mm	20	
M1107670	TERMINAL FEMALE POWER F800 8-10mm	20	
M1707670	TERMINAL FEMALE POWER F800 8-10mm (REEL)	650	
M1107700	TERMINAL MALE POWER WPM800 2.5-4mm	20	
M1107710	TERMINAL MALE POWER WPM800 6-8mm	20	
WATERPROOF POWER CONNECTOR & TERMINALS			
STOCK CODE	DESCRIPTION	OUTER QTY	PRODUCT
M4540210	2 WAY MALE POWER WATERPROOF (ANDERSON PLUG ALTERNATIVE)	10	
M4540110	2 WAY FEMALE POWER WATERPROOF WITH SECONDARY LOCK (ANDERSON PLUG ALTERNATIVE)	10	
M1707770	TERMINAL MALE POWER WP 6-8mm ²	10	
M1707410	TERMINAL FEMALE POWER WP 3-6mm ²	10	
M4550782	RED SILICON SEAL 4.9-5.7mm ²	20	

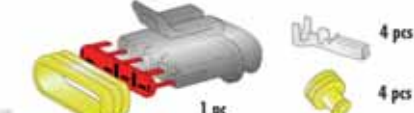

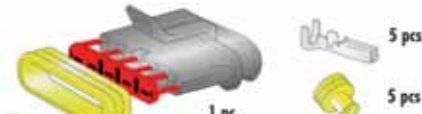





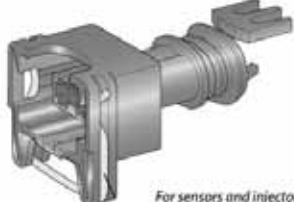

MTA SUPERSEAL CONNECTORS

Please Note: Commonly ordered items shown only, Full Range available upon request

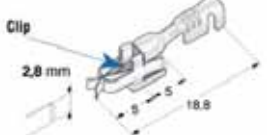
SUPERSEAL CONNECTORS				
PRODUCT	STOCK CODE	DESCRIPTION	OUTER QTY	
KIT  1 way	M3050123	SUPERSEAL 1 WAY MALE CONNECTOR KIT (1.5mm) INCLUDES TERMINAL M1105550 & SEAL M4407740	1	
KIT  1 way	M3050124	SUPERSEAL 1 WAY FEMALE CONNECTOR KIT (1.5mm) INCLUDES TERMINAL M1105560 & SEAL M4407740	1	
KIT  2 ways	M3050125	SUPERSEAL 2 WAY MALE CONNECTOR KIT (1.5mm) INCLUDES TERMINALS M1105550 & SEALS M4407740	1	
KIT  2 ways	M3050126	SUPERSEAL 2 WAY FEMALE CONNECTOR KIT (1.5mm) INCLUDES TERMINALS M1105560 & SEALS M4407740	1	
KIT  3 ways	M3050127	SUPERSEAL 3 WAY MALE CONNECTOR KIT (1.5mm) INCLUDES TERMINALS M1105550 & SEALS M4407740	1	
KIT  3 ways	M3050128	SUPERSEAL 3 WAY FEMALE CONNECTOR KIT (1.5mm) INCLUDES TERMINALS M1105560 & SEALS M4407740	1	
KIT  4 ways	M3050129	SUPERSEAL 4 WAY MALE CONNECTOR KIT (1.5mm) INCLUDES TERMINALS M1105550 & SEALS M4407740	1	
KIT  4 ways	M3050130	SUPERSEAL 4 WAY FEMALE CONNECTOR KIT (1.5mm) INCLUDES TERMINALS M1105560 & SEALS M4407740	1	
KIT  5 ways	M3050131	SUPERSEAL 5 WAY MALE CONNECTOR KIT (1.5mm) INCLUDES TERMINALS M1105550 & SEALS M4407740	1	
KIT  5 ways	M3050132	SUPERSEAL 5 WAY FEMALE CONNECTOR KIT (1.5mm) INCLUDES TERMINALS M1105560 & SEALS M4407740	1	
KIT  6 ways	M3050133	SUPERSEAL 6 WAY MALE CONNECTOR KIT (1.5mm) INCLUDES TERMINALS M1105550 & SEALS M4407740	1	
KIT  6 ways	M3050134	SUPERSEAL 6 WAY FEMALE CONNECTOR KIT (1.5mm) INCLUDES TERMINALS M1105560 & SEALS M4407740	1	



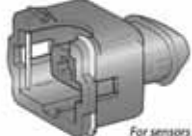

MTA JPT & JT SERIES

Please Note: Commonly ordered items shown only, Full Range available upon request

JPT SERIES CONNECTORS			
STOCK CODE	DESCRIPTION	OUTER QTY	PRODUCT
M4420910	2 WAY JPT CONNECTOR FOR SENSOR - BLACK	10	 <p><i>J.P.T.</i></p> <p>2 ways</p> <p><i>For sensors and injectors</i></p>
M4520910	2 WAY JPT CONNECTOR FOR SENSOR - BLACK	500	
M4410651	2 WAY JPT CONNECTOR FOR SENSOR - GREY	10	
M4410652	2 WAY JPT CONNECTOR FOR SENSOR - YELLOW	10	
M4410661	2 WAY JPT CONNECTOR FOR SENSOR - BLACK (MALE TERMINAL)	10	 <p><i>J.P.T.</i></p> <p>2 ways</p>
M4420911	RUBBER RIGHT ANGLE COVER FOR 2 WAY JPT CONNECTOR	10	 <p><i>For sensors and injectors</i></p> <p>Applications Moisture proof 2 ways connectors</p>
M1105620	TERMINAL FEMALE JPT F280 0.5-1.0mm	100	 <p>2,8 mm</p> <p>18,8</p>
M1107209	TERMINAL FEMALE JPT F280 W/CLIP 0.5 - 1.0mm	100	 <p>Clip</p> <p>2,8 mm</p> <p>5</p> <p>5</p> <p>18,8</p>
M1107212	TERMINAL FEMALE JPT F280 W/CLIP 1.5 - 2.5mm	100	
M1108290	TERMINAL MALE JPT WP M280 0.5 - 1.5mm	100	 <p>0,6</p> <p>2,8</p> <p>20,7</p>
M4510662	LIGHT BLUE RUBBER SEAL 0.5 - 1.0mm FOR JPT CONNECTORS	100	 
M4510658	WHITE RUBBER SEAL 1.5 - 2.5mm FOR JPT CONNECTORS	100	
JT SERIES CONNECTORS			
STOCK CODE	DESCRIPTION	OUTER QTY	PRODUCT
M4420900	2 WAY JT CONNECTOR FOR SENSOR-BLACK -FITS BOSCH FUEL INJECTION UNITS	10	 <p><i>J.T.</i></p> <p>2 ways</p> <p><i>For sensors and injectors</i></p>
M4520900	2 WAY JT CONNECTOR FOR SENSOR-BLACK -FITS BOSCH FUEL INJECTION UNITS	500	
M4420902	COVER L=37mm FOR 2 WAY JT CONNECTOR	10	 <p>37</p> <p>Applications Moisture proof 2 ways connectors</p>
M4520901	COVER L=57mm FOR 2 WAY JT CONNECTOR -FITS BOSCH FUEL INJECTION UNITS	10	
M1107211	TERMINAL JT F280 1.5 - 2.5mm	100	 <p>2,8 mm</p> <p>18,7</p>

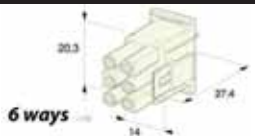
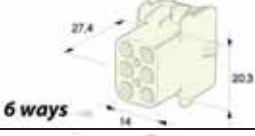
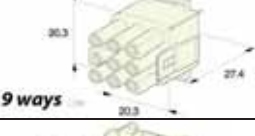
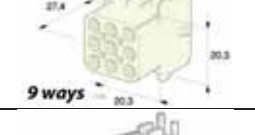
MTA MATE & LOCK & MULTIPLE 6.3

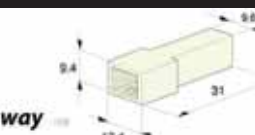
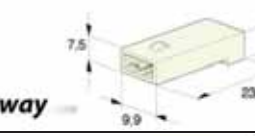
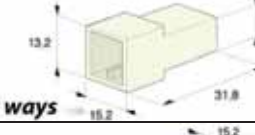
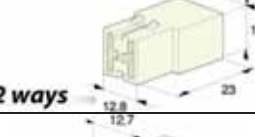
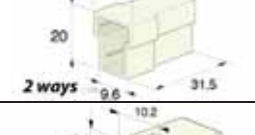
Please Note: Commonly ordered items shown only, Full Range available upon request

MATE & LOCK SERIES			
PRODUCT	STOCK CODE	DESCRIPTION	OUTER QTY
 <p>6 ways</p>	M4426110	MATE-N-LOCK 6 WAY MALE CONNECTOR WHITE	10
 <p>6 ways</p>	M4426120	MATE-N-LOCK 6 WAY FEMALE CONNECTOR WHITE	10
 <p>9 ways</p>	M4426130	MATE-N-LOCK 9 WAY MALE CONNECTOR WHITE	10
 <p>9 ways</p>	M4426140	MATE-N-LOCK 9 WAY FEMALE CONNECTOR WHITE	10
	M1201200	FEMALE TERMINAL TO SUIT MATE-N-LOCK F2	200
	M1201210	MALE TERMINAL TO SUIT MATE-N-LOCK M2	200
MULTIPLE 6.3 SERIES			
PRODUCT	STOCK CODE	DESCRIPTION	OUTER QTY
 <p>1 way</p>	M4410150	1 WAY MALE TERMINAL CONNECTOR SUITS FASTON M630 (W/LOCK)	100
 <p>1 way</p>	M4410160	1 WAY FEMALE TERMINAL CONNECTOR SUITS FASTON M630 (W/LOCK)	100
 <p>2 ways</p>	M4410170	2 WAY MALE TERMINAL CONNECTOR SUITS FASTON M630 (W/LOCK)	50
 <p>2 ways</p>	M4410180	2 WAY FEMALE TERMINAL CONNECTOR SUITS FASTON M630 (W/LOCK)	50
 <p>2 ways</p>	M4410190	2 WAY MALE-T TERMINAL CONNECTOR SUITS FASTON M630 (W/LOCK)	50
 <p>2 ways</p>	M4410200	2 WAY FEMALE-T TERMINAL CONNECTOR SUITS FASTON M630 (W/LOCK)	50

MTA MULTIPLE 6.3 SERIES

Please Note: Commonly ordered items shown only, Full Range available upon request

MULTIPLE 6.3 SERIES cont...			
STOCK CODE	DESCRIPTION	OUTER QTY	PRODUCT
M4410210	3 WAY MALE TERMINAL CONNECTOR SUITS FASTON M630 (W/LOCK)	50	
M4410220	3 WAY FEMALE TERMINAL CONNECTOR SUITS FASTON M630 (W/LOCK)	50	
M4410230	4 WAY MALE TERMINAL CONNECTOR SUITS FASTON M630 (W/LOCK)	25	
M4410240	4 WAY FEMALE TERMINAL CONNECTOR SUITS FASTON M630 (W/LOCK)	25	
M4410250	6 WAY MALE TERMINAL CONNECTOR SUITS FASTON M630 (W/LOCK)	25	
M4410260	6 WAY FEMALE TERMINAL CONNECTOR SUITS FASTON M630 (W/LOCK)	25	
M4410270	8 WAY MALE TERMINAL CONNECTOR SUITS FASTON M630 (W/LOCK)	20	
M4410280	8 WAY FEMALE TERMINAL CONNECTOR SUITS FASTON M630 (W/LOCK)	20	
M4410295	11 WAY MALE CONNECTOR	20	
M4410296	11 WAY FEMALE CONNECTOR	20	
M1301650	F630 FASTON BLADE TERMINAL FEMALE W/LOCKING NOTCH 1-2.5mm	100	
M1301660	M630 FASTON BLADE TERMINAL MALE W/LOCKING NOTCH 1-2.5mm	100	
M1101662	M630 FASTON BLADE TERMINAL MALE W/LOCKING NOTCH 4-6mm	100	

MTA PRE-INSULATED TERMINALS

Please Note: Commonly ordered items shown only, Full Range available upon request

PRE-INSULATED TERMINALS & CABLE CONNECTORS			
PRODUCT	STOCK CODE	DESCRIPTION	OUTER QTY
	M1851500	PUSH ON FEMALE INSULATED TERMINAL F630 RED	100
	M1855500	PUSH ON FEMALE INSULATED TERMINAL F630 BLUE	100
	M1852400	MALE BLADE INSULATED TERMINAL M630 RED	100
	M1856400	MALE BLADE INSULATED TERMINAL M630 BLUE	100
	M1864000	BULLET SINGLE MALE INSULATED TERMINAL RED	100
	M1864300	BULLET SINGLE MALE INSULATED TERMINAL BLUE	100
	M1864100	BULLET SINGLE FEMALE INSULATED TERMINAL RED	100
	M1864400	BULLET SINGLE FEMALE INSULATED TERMINAL BLUE	100
	M1868000	CABLE CONNECTOR INSULATED BUTT TERMINAL RED	100
	M1868100	CABLE CONNECTOR INSULATED BUTT TERMINAL BLUE	100
	M4410090	QUICK CONNECTOR INSULATED CABLE CONNECTOR RED	100
	M4410091	QUICK CONNECTOR INSULATED CABLE CONNECTOR BLUE	100
	M4410096	QUICK TAP CONNECTOR INSULATED CABLE CONNECTOR RED	50
	M4410097	QUICK TAP CONNECTOR INSULATED CABLE CONNECTOR BLUE	100









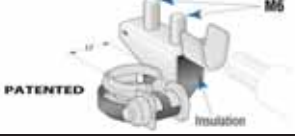

MTA RING TERMINALS, KITS & TOOLS

Please Note: Commonly ordered items shown only, Full Range available upon request

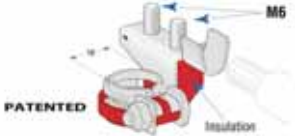
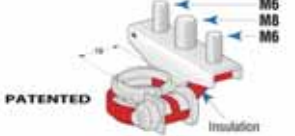
RING TERMINALS			
STOCK CODE	DESCRIPTION	OUTER QTY	PRODUCT
M1106700	M6 RING TERMINAL SUIT CABLE 4-6mm ²	100	
M1106750	M6 RING TERMINAL SUIT CABLE 8-10mm ²	100	
M1106710	M8 RING TERMINAL SUIT CABLE 4-6mm ²	100	
M1106760	M8 RING TERMINAL SUIT CABLE 8-10mm ²	100	
M1608190	RING TERMINAL MEGA G90M8 25-35mm ² CABLE M8	50	
M1605600	RING TERMINAL MIDI G90M5 2.5-4mm ² CABLE M5	50	
M1605700	RING TERMINAL MIDI G90M5 6-8mm ² CABLE M5	50	
M1605800	RING TERMINAL MIDI G90M5 10-16mm ² CABLE M5	50	
M1605900	RING TERMINAL MIDI G90M5 25-35mm ² CABLE M5	50	
M1706950	RING TERMINAL SQR-A M8 10-20mm CABLE (REEL OF 600)	1	
TERMINAL ASSEMBLY KITS & TOOLS			
STOCK CODE	DESCRIPTION	OUTER QTY	PRODUCT
M1606820	NON-INSULATED TERMINAL ASSORTMENT BOX	1	
M1606940	BLADE & COVER TERMINAL ASSORTMENT BLISTER CARD 80 pcs	1	
M1606950	BLADE & RING TERMINAL ASSORTMENT BLISTER CARD 90 pcs	200	
M9602455	CRIMPING TOOL FOR TERMINALS	1	





MTA BATTERY TERMINALS

Please Note: Commonly ordered items shown only, Full Range available upon request

BATTERY TERMINALS			
PRODUCT	STOCK CODE	DESCRIPTION	OUTER QTY
	M1506691	M66(-) BATTERY TERMINAL DOUBLE RING, BLACK, 17mm	10
	M1507905	M666(-) SX BATTERY TERMINAL "QUICK LOCK" FOR QUICK RELEASE	100
	M1507915	M666(-) DX BATTERY TERMINAL "QUICK LOCK" FOR QUICK RELEASE	100
	M1506270	DIE CAST(+) BATTERY TERMINAL 19mm	25
	M1506280	DIE CAST(-) BATTERY TERMINAL 17mm	25
	M1506611	M66(+) BATTERY TERMINAL RED 25-40mm CABLE, DOUBLE RING	10
	M1506621	M686(+) BATTERY TERMINAL RED DOUBLE RING 19mm SUITS M0100011	10
	M1506701	M686(-) BATTERY TERMINAL BLACK DOUBLE RING 17mm	10
	M4410500	M66(+) RED TERMINAL COVER	10
	M4410490	M686(+) RED TERMINAL COVER	10
	M4410494	M686(-) BLACK TERMINAL COVER	10
	M1506631	BATTERY TERMINAL 2 RINGS	10
	M1506645	BATTERY TERMINAL 2 RINGS M606	100

MTA BATTERY TERMINALS

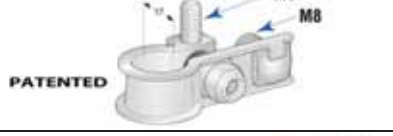
Please Note: Commonly ordered items shown only, Full Range available upon request

STRIP TYPE BATTERY TERMINALS			
STOCK CODE	DESCRIPTION	OUTER QTY	PRODUCT
M1506660	BATTERY TERMINAL STRIP TYPE M6	100	
M1506665	BATTERY TERMINAL STRIP TYPE	100	
M1506670	BATTERY TERMINAL STRIP TYPE M6/M8	100	
M1506675	BATTERY TERMINAL STRIP TYPE M8	100	
M1506730	BATTERY TERMINAL STRIP TYPE 19mm(+)	100	

OTHER MTA STOCK...



For further information, or the full range of MTA Items, please see www.MTA.IT



We can order most MTA parts by Special Order. Please speak to our sales representatives.