

# LED TRUCK & TRAILER LAMPWARE



LED SIDE MARKER & OUTLINE LAMPS

LED LICENCE PLATE LAMPS

LED COMBINATION & SINGLE LAMPS

## FEATURES

- **LED (Light Emitting Diode)** Multi-Voltage Lamps ensure a uniform level of light intensity at any voltage from 7 to 33 volts, and are fully weather-sealed and submersible to a depth of 50cm.
- **The LED** medium size chip used throughout our rear signal lamps provide more light with lower power consumption, thus producing less heat and providing a longer life.
- **All Pro Quip** LED Lamps are fully ADR/ECE Compliant, ROHS & EMC Compliant and Reverse-Polarity and Transient-Spike protected.
- **The LED Circuit** board has been tested to comply with the internationally recognised "Military Specifications", providing a reliable and durable product.
- **LED Lamps** are manufactured from UV resistant Polycarbonate and have a Common Mounting Footprint with other lamps.

# LED COMBINATION LAMPS

## LED COMBINATION LAMPS

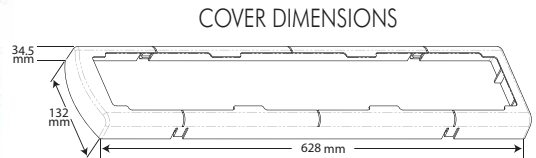
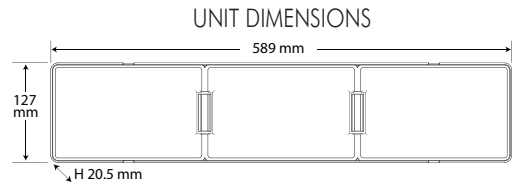

| DESCRIPTION  |   | STOCK CODE                          |
|--|---|-------------------------------------|
| Triple LED Combination Lamp with inbuilt Retro Reflector Supplied with Black Top Cover |   | 89310                               |
| Description:   | LED Stop, Tail, Rear Direction Indicator Lamp with inbuilt retro reflector. |                                     |
| Voltage:   | Multi-voltage 7-33V DC  |                                     |
| Mounting:  | Surface mount   |                                     |
| Orientation:   | Compliant for Horizontal and Vertical mounting                              |                                     |
| Lead Length:   | 0.5 metre with Superseal waterproof connector and pigtail loom              |                                     |
|  |   |                                     |
| Spare Parts:   | Triple Black Housing 89301  | Chrome Triple Top Cover 89303       |
|  | Black Triple Top Cover 89302  | LED Stop/Rear Position Insert 89105 |
|  | LED Rear Direction Indicator Insert 89107                                   |                                     |

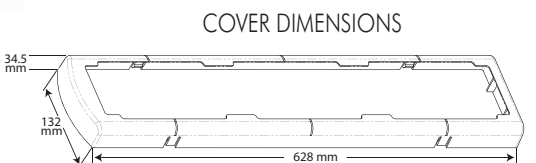
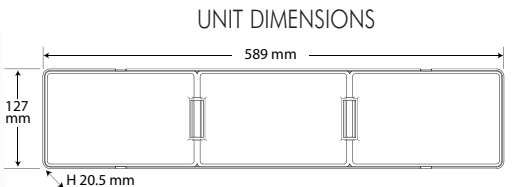

| DESCRIPTION   |   | STOCK CODE                          |
|---|---|-------------------------------------|
| Triple LED Combination Lamp with Reverse lamp and inbuilt Retro Reflector Supplied with Black Top Cover |   | 89330                               |
| Description:  | LED Stop/Tail, Rear Direction Indicator, Reversing Lamp with inbuilt retro reflector. |                                     |
| Voltage:  | Multi-voltage 7-33V DC  |                                     |
| Mounting:   | Surface mount   |                                     |
| Orientation:  | Compliant for Horizontal and Vertical mounting  |                                     |
| Lead Length:  | 0.5 metre with Superseal waterproof connector and pigtail loom                        |                                     |
|   |   |                                     |
| Spare Parts:  | Triple Black Housing 89301  | Chrome Triple Top Cover 89303       |
|   | Black Triple Top Cover 89302  | LED Stop/Rear Position Insert 89105 |
|   | LED Rear Direction Indicator Insert 89107   | LED Reverse Insert 89109            |

# LED COMBINATION LAMPS

## LED COMBINATION LAMPS

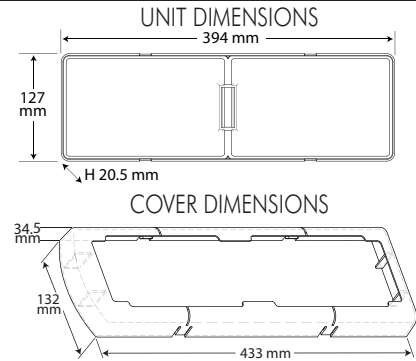

### DESCRIPTION

### STOCK CODE

Double LED Combination Lamp and inbuilt Retro Reflector Supplied with Black Top Cover

89260

Description: LED Stop/Tail, Rear Direction Indicator with inbuilt retro reflector.  
 Voltage: Multi-voltage 7-33V DC  
 Mounting: Surface mount  
 Orientation: Compliant for Horizontal and Vertical mounting  
 Lead Length: 0.5 metre with Superseal waterproof connector and pigtail loom



Spare Parts: Double Black Housing 89201 Chrome Double Top Cover 89203  
 Black Double Top Cover 89202 LED Stop/Rear Position Insert 89105  
 LED Rear Direction Indicator Insert 89107



ILLUMINATED UNIT

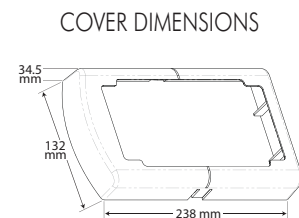
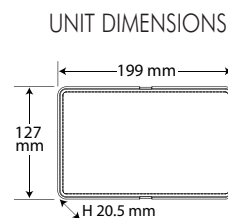

### DESCRIPTION

### STOCK CODE

LED Triple Combination lamp with inbuilt Retro Reflector with 0.5 Metre Lead Supplied with Black Top Cover with Superseal waterproof connector and pigtail loom

89610

LED Triple Combination lamp with inbuilt Retro Reflector with 6 Metre Lead Supplied with Black Top Cover with Superseal waterproof connector and pigtail loom

89620

Description: LED Stop/Tail/Rear Direction Indicator Lamp with inbuilt Retro Reflector.  
 Voltage: Multi-voltage 7-33V DC  
 Mounting: Surface mount  
 Orientation: Compliant for Horizontal and Vertical mounting  
 No. of LEDs: 24 LEDs forming a matrix of 4 x 6 for lamp unit



Spare Parts: Single Black Housing 89101 Chrome Single Top Cover 89103  
 Black Single Top Cover 89102 LED Combination Lamp Insert 89601

# LED SINGLE LAMPS

## LED SINGLE LAMPS

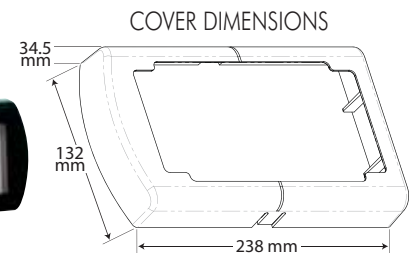
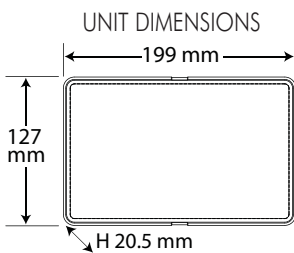

| DESCRIPTION   |  | STOCK CODE  |
|---|--|---|
| LED Stop/ Tail Lamp Inbuilt Retro Reflector Supplied with Black Top Cover<br><br>Description: LED Stop/Tail Lamp with inbuilt retro reflector<br>Voltage: Multi-voltage 7-33V DC<br>Mounting: Surface mount<br>Orientation: Compliant for Horizontal and Vertical mounting<br>No. of LEDs: 24 LEDs forming a matrix of 4 x 6 for lamp unit<br>Lead Length: 0.5 metre with Superseal waterproof connector and pigtail loom |  | 89110<br><br>   |
| LED Rear Direction Indicator Lamp Supplied with Black Top Cover<br><br>Description: LED Rear Direction Indicator<br>Voltage: Multi-voltage 7-33V DC<br>Mounting: Surface mount<br>Orientation: Compliant for Horizontal and Vertical mounting<br>No. of LEDs: 24 LEDs forming a matrix of 4 x 6 for lamp unit<br>Lead Length: 0.5 metre with Superseal waterproof connector and pigtail loom                              |  | 89130<br><br>   |
| LED Reverse Lamp Supplied with Black Top Cover<br><br>Description: LED Reverse Lamp<br>Voltage: Multi-voltage 7-33V DC<br>Mounting: Surface mount<br>Orientation: Compliant for Horizontal and Vertical mounting<br>No. of LEDs: 24 LEDs forming a matrix of 4 x 6 for lamp unit<br>Lead Length: 0.5 metre with Superseal waterproof connector and pigtail loom   |  | 89150<br><br>   |
| Spare Parts:  | Single Black Housing 89101<br>Black Single Top Cover 89102<br>LED Reverse Insert 89109 | Chrome Single Top Cover 89103<br>LED Stop/Rear Position Insert 89105<br>LED Rear Direction Indicator Insert 89107 |